

DIANWEI ELECTRONIC TECHNOLOGY CO.,LTD

Dongguan Dianwei Electronic Technology Co.,Ltd
Shenzhen Dianwei Technology Co.,Ltd

COMPANY PROFILE

Dianwei company is specialized in manufacturing of precision electronic connector products. The company continues increasing its R&D, innovation investment since its founded year of 2006. It following the ISO9001 quality system strictly and had won 14 patents in China. The manufacture plant is located in TangXia town, DongGuan city of which cover a land area of 8200 square meters. beautiful environment and convenient transportation. Dianwei company had got the widely customer praise (like BBK etc) depends on its stable and reliable product quality and professional services. Dianwei company obtained National high-tech enterprises in year 2017.

Dianwei company provides a full set of technical support and service from the product innovation design, plastic and hardware molding design, product manufacturing and automation assembly. We had developed a variety of connectors and precision components for many famous companies from Germany and Japan. Our independent research and development of the 0.3-1.0mm spacing of double contact lock type FFC/FPC electronic connector products are widely used in computer, tablet PCs, smart phones, communications equipment, smart wearable devices, digital cameras, LCD TV, car information systems, medical, security, smart home and other fields.

Development History

2006

Dianwei was founded and registered in Futian,shenzhen

2009

Built plant & independent R&D & prodction line & sales

2010

Mass production for 8.01 series connector

2012

Mass production for 8.02 series connector

2014

Plant moved to Tangxia town,mass production for 8.03A0 & 8.04A0 series connector

2015

Mass production for 8.07 series connector

2016

Mass production for 8.05 series connector

2017

Mass production for 8.12 & 8.13 series connector

2018

Obtained national high-tech interprises , IATF16949 quality control system

Enterprise certification :

- 1.144 kinds of EU REACH environmental protection certificates
- 2.ISO9001:2008 International Quality System Certification
- 3.ISO14000 Environment management system Certification (training)
- 4.ISOTS16949 Quality system certification (training)



Honor :

- 1.Quality supplier of large-lot enterprise
- 2.Obtained 14 patents in china(2 patents for invention&12 utility model patents)



Enterprise certification :



144 kinds of EU REACH environmental protection certificates



ISO9001:2008 International Quality System Certification



ISO14000 Environment management system Certification (training)



ISOTS16949 Quality system certification (training)

Sales amount & production capacity

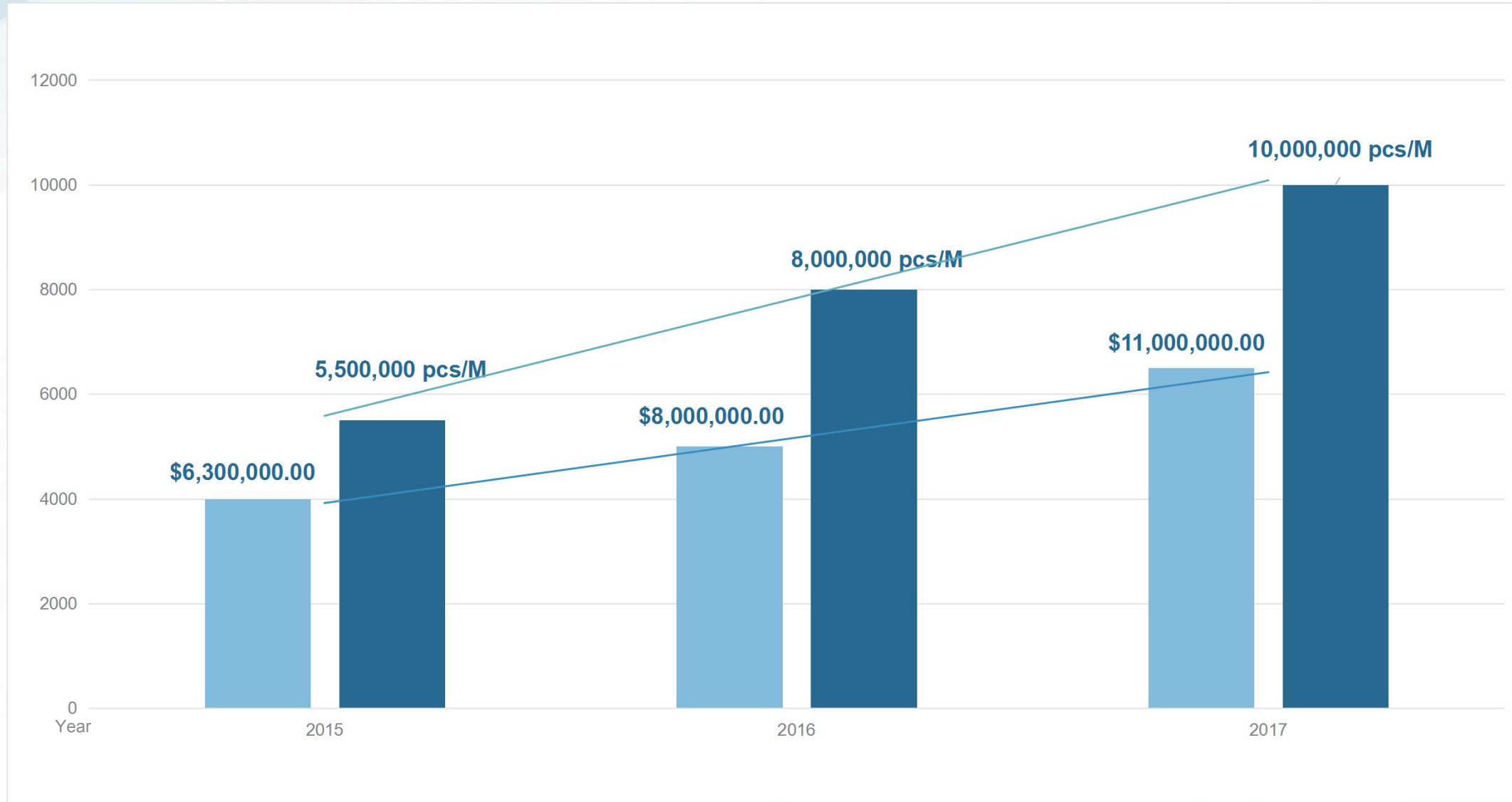

DIANWEI



Manufacturing Workshop



Automated Workshop



Inspection Facilities



DIANWEI FFC/FPC Connector

Back locking type

8.01A0 series 0.5mm pitch
8.02A0 series 0.5mm pitch
8.03A0 series 0.3mm pitch
8.04A0 series 1.0mm pitch
8.07A0 series 0.5mm pitch
8.10A0 series 0.5mm pitch
8.19A0 series 0.5mm pitch

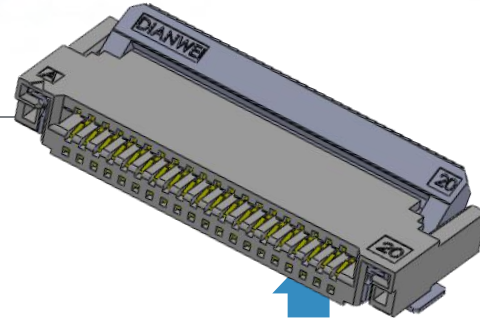

Vertical type

8.12A0 series 0.5mm pitch

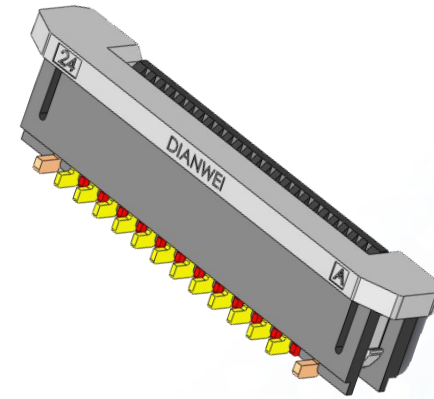

Flip-lock type

8.05A0 series 0.5mm pitch
8.08A0 series 0.5mm pitch
8.09A0 series 0.5mm pitch

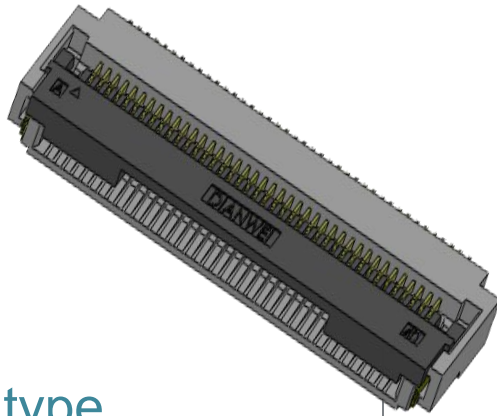

FFC/FPC
connector

Horizontal type

8.13A0 series 0.5mm pitch

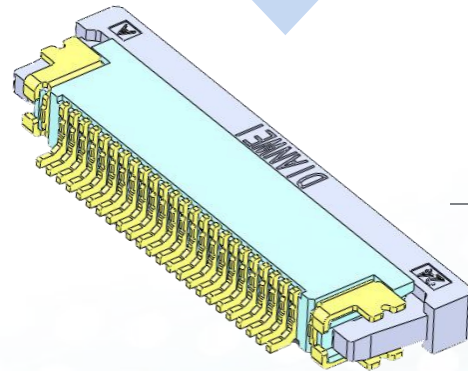

DIANWEI FFC/FPC Connector

Name	Type	Pitch	Height	Dianwei P/N	Contact PIN No.	Replace
FFC/FPC connector	back locking	0.3mm	0.9mm	8.03A0.***200	9P、11P、13P、15P、17P、19P、21P、23P、25P、27P、31P、33P、35P、39P、41P、45P、51P、57P、61P	HRS FH35C SCG BL143
		0.5mm	1.0mm	8.07A0.***200	4P、6P、8P、9P、10P、12P、14P、16P、18P、20P、22P、24P、30P、34P、40P、42P、50P	HRS FH34 SCG BL509 PANASONIC Y5B
			1.2mm	8.02A0.***200	4P、5P、6P、7P、8P、10P、12P、14P、15P、16P、20P、24P、28P、30P、32P、34P、35P、36P、40P、45P、50P、52P、56P、60P	dual contact horizontal/swing cover
			2.0mm	8.01A0.***200	4P、6P、8P、9P、10P、12P、14P、15P、16P、18P、20P、22P、24P、26P、28P、30P、32P、34P、35P、36P、40P、41P、42P、45P、50P、51P、52P、54P、55P、60P	OMRON XF3M
				8.19A0.***200	4P、6P、8P、9P、10P、12P、14P、15P、16P、18P、20P、22P、24P、26P、28P、30P、32P、34P、35P、36P、40P、41P、42P、45P、50P、51P、52P、54P、55P、60P	OMRON XF2M
	1.0mm	2.0mm	8.04A0.***200	4P、5P、6P、8P、10P、12P、13P、14P、15P、16P、18P、20P、22P、24P、26P、27P、28P、30P、36P、40P	dual contact horizontal/swing cover	
	swing cover	0.5mm	1.8mm	8.05A0.***200	10P、20P、24P、30P、40P、45P、50P、60P、68P、80P、96P	HRS FH52 P-TWO JB96
	vertical	0.5mm	4.6mm	8.12A0.***200	24p	MOLEX 052559
	horizontal	0.5mm	2.0mm	8.13A0.***200	24p	MOLEX 052746

8.01A0 Series 0.5mm FFC/FPC dual side contact connector H=2.0mm

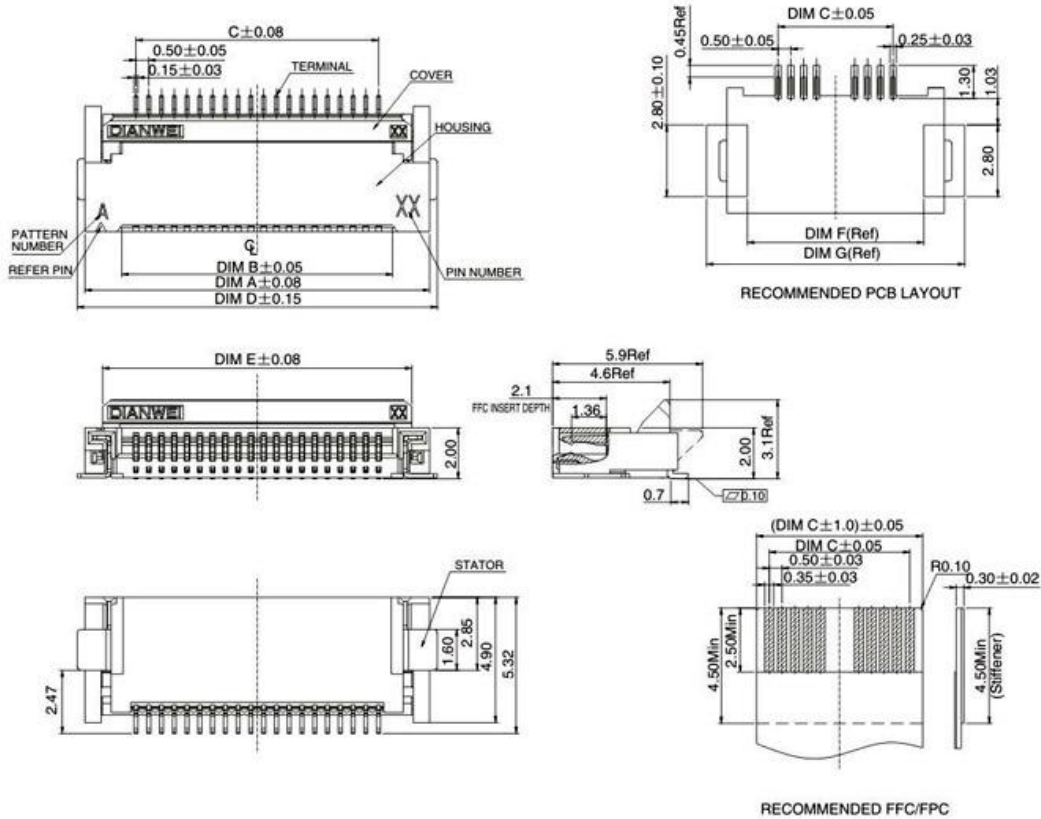

Pin No.	P/N	DIM A	DIM B	DIM C	DIM D	DIM E	DIM F	DIM G
4	8.01A0.004200	5.50	2.55	1.50	6.10	4.10	3.90	7.10
5	8.01A0.005200	6.00	3.05	2.00	6.60	4.60	4.40	7.60
6	8.01A0.006200	6.50	3.55	2.50	7.10	5.10	4.90	8.10
8	8.01A0.008200	7.50	4.55	3.50	8.10	6.10	5.90	9.10
9	8.01A0.009200	8.00	5.05	4.00	8.60	6.60	6.40	9.60
10	8.01A0.010200	8.50	5.55	4.50	9.10	7.10	6.90	10.10
12	8.01A0.012200	9.50	6.55	5.50	10.10	8.10	7.90	11.10
14	8.01A0.014200	10.50	7.55	6.50	11.10	9.10	8.90	12.10
15	8.01A0.015200	11.00	8.05	7.00	11.60	9.60	9.40	12.60
16	8.01A0.016200	11.50	8.55	7.50	12.10	10.10	9.90	13.10
18	8.01A0.018200	12.50	9.55	8.50	13.10	11.10	10.90	14.10
20	8.01A0.020200	13.50	10.55	9.50	14.10	12.10	11.90	15.10
22	8.01A0.022200	14.50	11.55	10.50	15.10	13.10	12.90	16.10
24	8.01A0.024200	15.50	12.55	11.50	16.10	14.10	13.90	17.10
26	8.01A0.026200	16.50	13.55	12.50	17.10	15.10	14.90	18.10
28	8.01A0.028200	17.50	14.55	13.50	18.10	16.10	15.90	19.10
30	8.01A0.030200	18.50	15.55	14.50	19.10	17.10	16.90	20.10
32	8.01A0.032200	19.50	16.55	15.50	20.10	18.10	17.90	21.10
34	8.01A0.034200	20.50	17.55	16.50	21.10	19.10	18.90	22.10
35	8.01A0.035200	21.00	18.05	17.00	21.60	19.60	19.40	22.60
36	8.01A0.036200	21.50	18.55	17.50	22.10	20.10	19.90	23.10
38	8.01A0.038200	22.50	19.55	18.50	23.10	21.10	20.90	24.10
40	8.01A0.040200	23.50	20.55	19.50	24.10	22.10	21.90	25.10
41	8.01A0.041200	24.00	21.05	20.00	24.60	22.60	22.40	25.60
42	8.01A0.042200	24.50	21.55	20.50	25.10	23.10	22.90	26.10
45	8.01A0.045200	26.00	23.05	22.00	26.60	24.60	24.40	27.60
50	8.01A0.050200	28.50	25.55	24.50	29.10	27.10	26.90	30.10
51	8.01A0.051200	29.00	26.05	25.00	29.60	27.60	27.40	30.60
52	8.01A0.052200	29.50	26.55	25.50	30.10	28.10	27.90	31.10
54	8.01A0.054200	30.50	27.55	26.50	31.10	29.10	28.90	32.10
55	8.01A0.055200	31.00	28.05	27.00	31.60	29.60	29.40	32.60
58	8.01A0.058200	32.50	29.55	28.50	33.10	31.10	30.90	34.10
60	8.01A0.060200	33.50	30.55	29.50	34.10	32.10	31.90	35.10

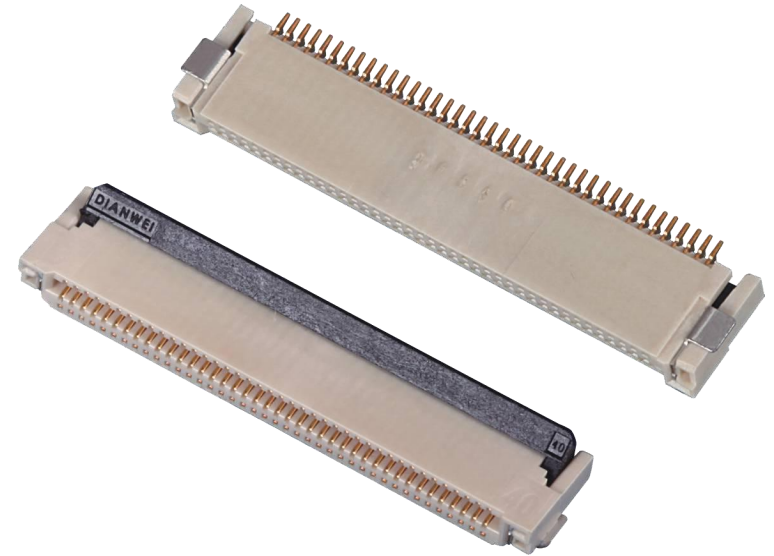

Application :

car information systems (GPS/DVD etc) , tablet PCs , computer , medical , industrial control etc

Main technical parameters :

rating voltage : 50V (AC/DC) contact resistance : 100mΩ Max
 rating current : 0.5A/PIN insulation resistance : 50MΩ Min
 retention force : > 0.5N/PIN

Material :

Housing & Cover : LCP contact terminal : phosphor bronze,Au plating

Contact type : double contact

Packing : 1500PCS/reel

thickness of flat cable : 0.3+/-0.02mm

PIN No. :

4P、6P、8P、9P、10P、12P、14P、15P、16P、18P、20P、22P、24P、26P、28P、30P、32P、34P、35P、36P、40P、41P、42P、45P、50P、51P、52P、54P、55P、60P。

8.02A0 Series 0.5mm FFC/FPC dual side contact connector H=1.2mm

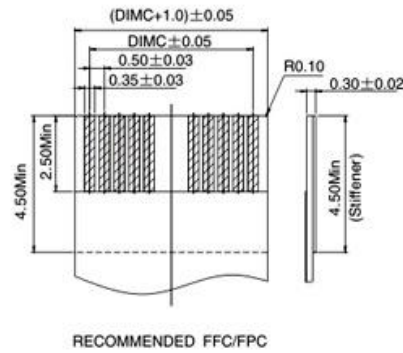
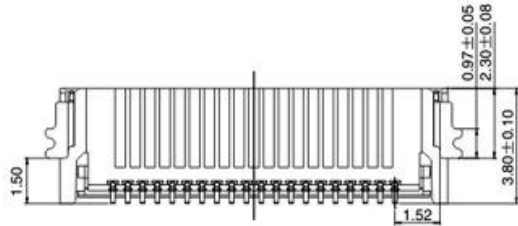
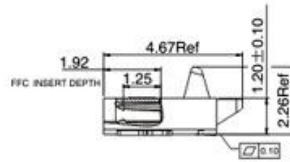
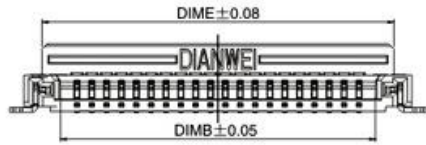
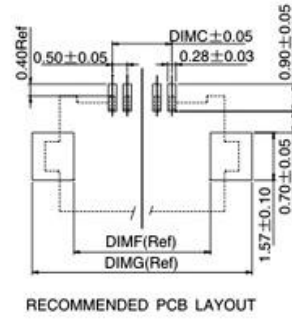
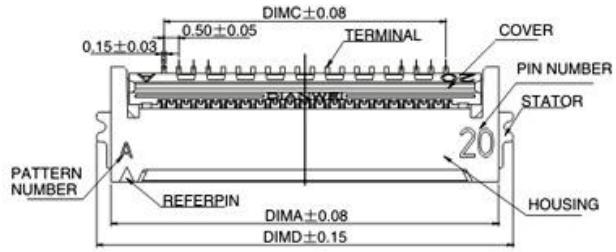

Pin No.	P/N	A	B	C	D	E	F	G
4	8.02A0.004200	5.06	2.55	1.50	6.00	3.85	4.10	6.90
5	8.02A0.005200	5.56	3.05	2.00	6.50	4.35	4.60	7.40
6	8.02A0.006200	6.06	3.55	2.50	7.00	4.85	5.10	7.90
7	8.02A0.007200	6.56	4.05	3.00	7.50	5.35	5.60	8.40
8	8.02A0.008200	7.06	4.55	3.50	8.00	5.85	6.10	8.90
10	8.02A0.010200	8.06	5.55	4.50	9.00	6.85	7.10	9.90
12	8.02A0.012200	9.06	6.55	5.50	10.00	7.85	8.10	10.90
14	8.02A0.014200	10.06	7.55	6.50	11.00	8.85	9.10	11.90
15	8.02A0.015200	10.56	8.05	7.00	11.50	9.35	9.60	12.40
16	8.02A0.016200	11.06	8.55	7.50	12.00	9.85	10.10	12.90
18	8.02A0.018200	12.06	9.55	8.50	13.00	10.85	11.10	13.90
20	8.02A0.020200	13.06	10.55	9.50	14.00	11.85	12.10	14.90
22	8.02A0.022200	14.06	11.55	10.50	15.00	12.85	13.10	15.90
24	8.02A0.024200	15.06	12.55	11.50	16.00	13.85	14.10	16.90
25	8.02A0.025200	15.56	13.05	12.00	16.50	14.35	14.60	17.40
26	8.02A0.026200	16.06	13.55	12.50	17.00	14.85	15.10	17.90
28	8.02A0.028200	17.06	14.55	13.50	18.00	15.85	16.10	18.90
30	8.02A0.030200	18.06	15.55	14.50	19.00	16.85	17.10	19.90
32	8.02A0.032200	19.06	16.55	15.50	20.00	17.85	18.10	20.90
34	8.02A0.034200	20.06	17.55	16.50	21.00	18.85	19.10	21.90
35	8.02A0.035200	20.56	18.05	17.00	21.50	19.35	19.60	22.40
36	8.02A0.036200	21.06	18.55	17.50	22.00	19.85	20.10	22.90
40	8.02A0.040200	23.06	20.55	19.50	24.00	21.85	22.10	24.90
42	8.02A0.042200	24.06	21.55	20.50	25.00	22.85	23.10	25.90
45	8.02A0.045200	25.56	23.05	22.00	26.50	24.35	24.60	27.40
50	8.02A0.050200	28.06	25.55	24.50	29.00	26.85	27.10	29.90
52	8.02A0.052200	29.06	26.55	25.50	30.00	27.85	28.10	30.90
54	8.02A0.054200	30.06	27.55	26.50	31.00	28.85	29.10	31.90
56	8.02A0.056200	31.06	28.55	27.50	32.00	29.85	30.10	32.90
60	8.02A0.060200	33.06	30.55	29.50	34.00	31.85	32.10	34.90

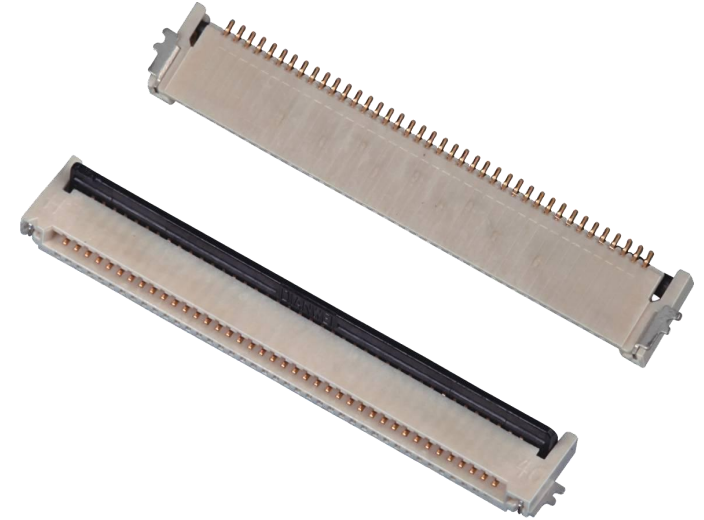

Application :

car information systems (GPS/DVD etc) , tablet PCs , computer , medical , industrial control etc

Main technical parameters :

rating voltage : 50V (AC/DC) contact resistance : 100mΩ Max
 rating current : 0.5A/PIN insulation resistance : 50MΩ Min
 retention force : > 0.5N/PIN

Material :

Housing & Cover : LCP contact terminal : phosphor bronze,Au plating

Contact type : double contact

Packing : 3000PCS/reel

thickness of flat cable : 0.3+/-0.02mm

PIN No.:

4P、5P、6P、7P、8P、10P、12P、14P、15P、16P、20P、24P、28P、30P、32P、34P、35P、36P、40P、45P、50P、52P、56P、60P。

8.03A0 Series 0.3mm FFC/FPC dual side contact connector H=0.9mm

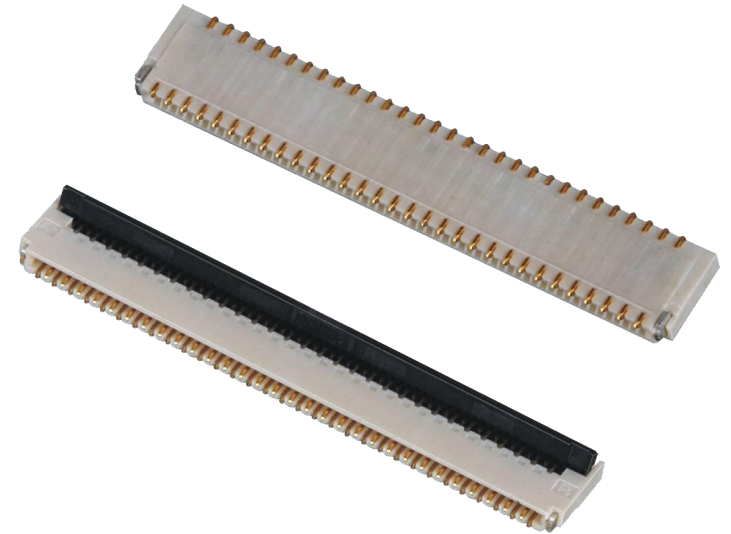
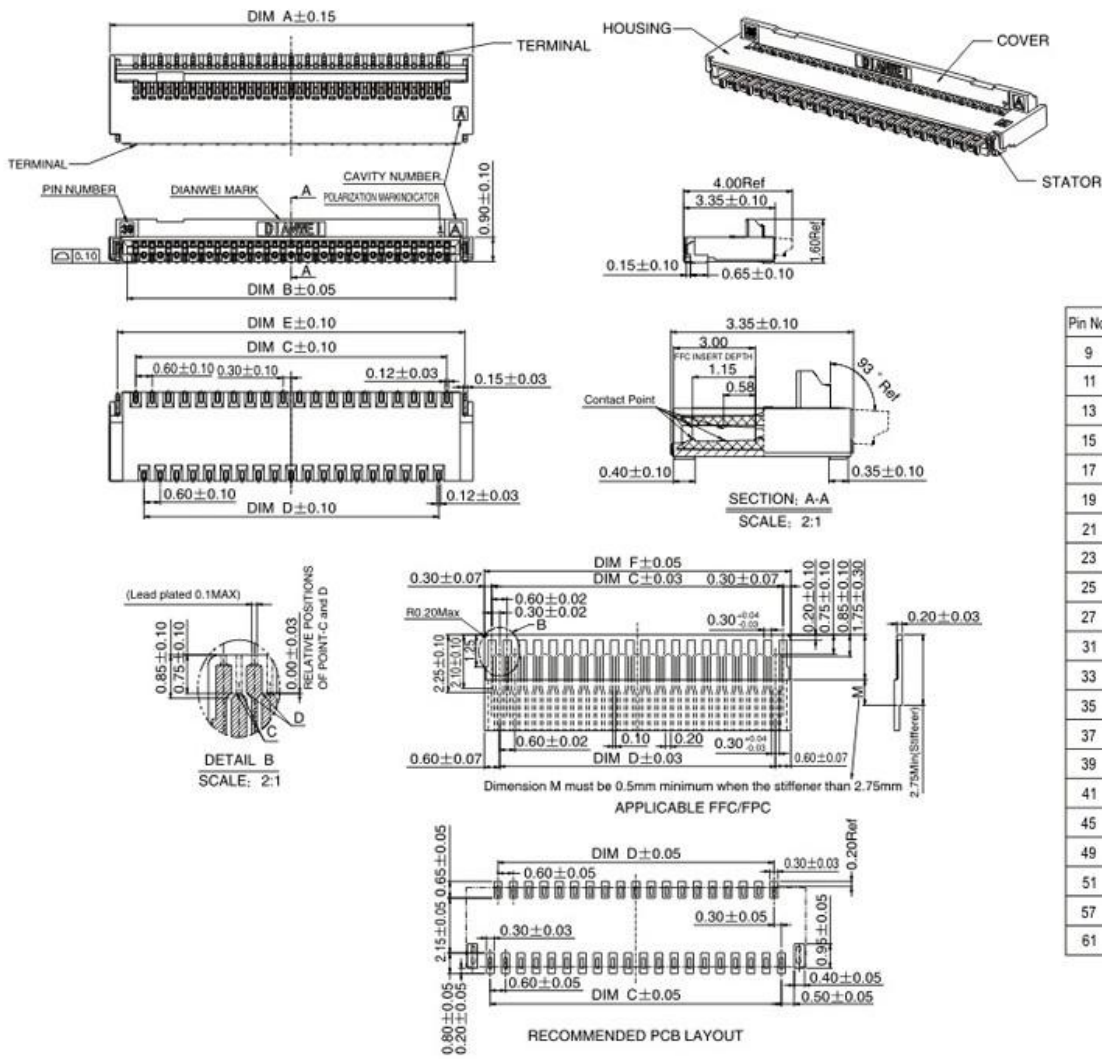

Pin No.	P/N	DIM A	DIM B	DIM C	DIM D	DIM E	DIM F
9	8.03A0.009200	4.30	3.03	2.40	1.80	3.73	3.00
11	8.03A0.011200	4.90	3.63	3.00	2.40	4.33	3.60
13	8.03A0.013200	5.50	4.23	3.60	3.00	4.93	4.20
15	8.03A0.015200	6.10	4.83	4.20	3.60	5.53	4.80
17	8.03A0.017200	6.70	5.43	4.80	4.20	6.13	5.40
19	8.03A0.019200	7.30	6.03	5.40	4.80	6.73	6.00
21	8.03A0.021200	7.90	6.63	6.00	5.40	7.33	6.60
23	8.03A0.023200	8.50	7.23	6.60	6.00	7.93	7.20
25	8.03A0.025200	9.10	7.83	7.20	6.60	8.53	7.80
27	8.03A0.027200	9.70	8.43	7.80	7.20	9.13	8.40
31	8.03A0.031200	10.90	9.63	9.00	8.40	10.33	9.60
33	8.03A0.033200	11.50	10.23	9.60	9.00	10.93	10.20
35	8.03A0.035200	12.10	10.83	10.20	9.60	11.53	10.80
37	8.03A0.037200	12.70	11.43	10.80	10.20	12.13	11.40
39	8.03A0.039200	13.30	12.03	11.40	10.80	12.73	12.00
41	8.03A0.041200	13.90	12.63	12.00	11.40	13.33	12.60
45	8.03A0.045200	15.10	13.83	13.20	12.60	14.53	13.80
49	8.03A0.049200	16.30	15.03	14.40	13.80	15.73	15.00
51	8.03A0.051200	16.90	15.63	15.00	14.40	16.33	15.60
57	8.03A0.057200	18.70	17.43	16.80	16.20	18.13	17.40
61	8.03A0.061200	19.90	18.63	18.00	17.40	19.33	18.60

Application :

tablet PCs , smart phones,communications equipment , digital electronics etc

main technical parameters :

rating voltage : 50V (AC/DC) contact resistance : 100mΩ Max
 rating current:0.5A/PIN insulation resistance : 50MΩ Min
 retention force : > 0.3N/PIN

material :

Housing & cover : LCP contact terminal: phosphor bronze,Au plating

contact type : double contact

packing : 3000PCS/reel

thickness of flat cable : 0.2+/-0.02mm

PIN No. :

9P、11P、13P、15P、17P、19P、21P、23P、25P、27P、31P、33P、35P、39P、41P、45P、51P、57P、61P

8.04A0 Series 1.0mm FFC/FPC dual side contact connector H=2.0mm

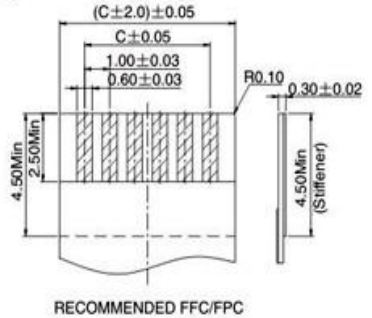
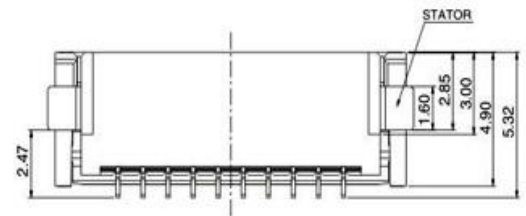
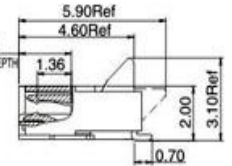
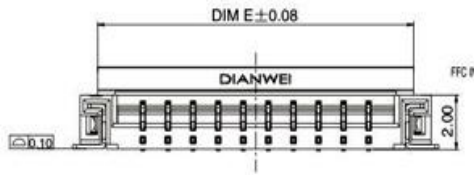
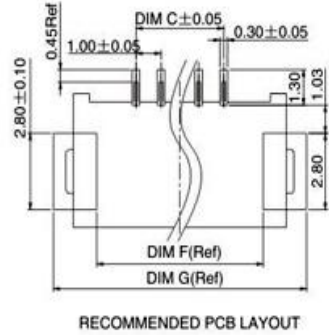
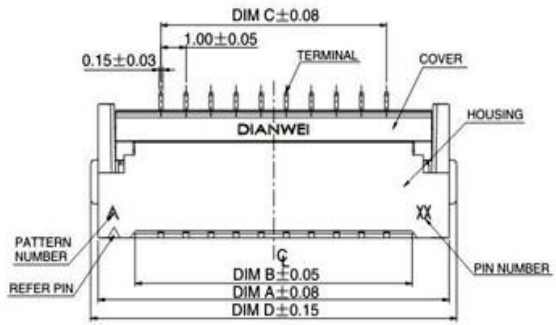

Pin No.	P/N	DIM A	DIM B	DIM C	DIM D	DIM E	DIM F	DIM G
4	8.04A0.004200	8.00	5.05	3.00	8.60	6.60	6.40	9.60
5	8.04A0.005200	9.00	6.05	4.00	9.60	7.60	7.40	10.60
6	8.04A0.006200	10.00	7.05	5.00	10.60	8.60	8.40	11.60
7	8.04A0.007200	11.00	8.05	6.00	11.60	9.60	9.40	12.60
8	8.04A0.008200	12.00	9.05	7.00	12.60	10.60	10.40	13.60
9	8.04A0.009200	13.00	10.05	8.00	13.60	11.60	11.40	14.60
10	8.04A0.010200	14.00	11.05	9.00	14.60	12.60	12.40	15.60
11	8.04A0.011200	15.00	12.05	10.00	15.60	13.60	13.40	16.60
12	8.04A0.012200	16.00	13.05	11.00	16.60	14.60	14.40	17.60
13	8.04A0.013200	17.00	14.05	12.00	17.60	15.60	15.40	18.60
14	8.04A0.014200	18.00	15.05	13.00	18.60	16.60	16.40	19.60
15	8.04A0.015200	19.00	16.05	14.00	19.60	17.60	17.40	20.60
16	8.04A0.016200	20.00	17.05	15.00	20.60	18.60	18.40	21.60
17	8.04A0.017200	21.00	18.05	16.00	21.60	19.60	19.40	22.60
18	8.04A0.018200	22.00	19.05	17.00	22.60	20.60	20.40	23.60
19	8.04A0.019200	23.00	20.05	18.00	23.60	21.60	21.40	24.60
20	8.04A0.020200	24.00	21.05	19.00	24.60	22.60	22.40	25.60
21	8.04A0.021200	25.00	22.05	20.00	25.60	23.60	23.40	26.60
22	8.04A0.022200	26.00	23.05	21.00	26.60	24.60	24.40	27.60
23	8.04A0.023200	27.00	24.05	22.00	27.60	25.60	25.40	28.60
24	8.04A0.024200	28.00	25.05	23.00	28.60	26.60	26.40	29.60
25	8.04A0.025200	29.00	26.05	24.00	29.60	27.60	27.40	30.60
26	8.04A0.026200	30.00	27.05	25.00	30.60	28.60	28.40	31.60
27	8.04A0.027200	31.00	28.05	26.00	31.60	29.60	29.40	32.60
28	8.04A0.028200	32.00	29.05	27.00	32.60	30.60	30.40	33.60
29	8.04A0.029200	33.00	30.05	28.00	33.60	31.60	31.40	34.60
30	8.04A0.030200	34.00	31.05	29.00	34.60	32.60	32.40	35.60
36	8.04A0.036200	40.00	37.05	35.00	40.60	38.60	38.40	41.60
40	8.04A0.040200	44.00	41.05	39.00	44.60	42.60	42.40	45.60

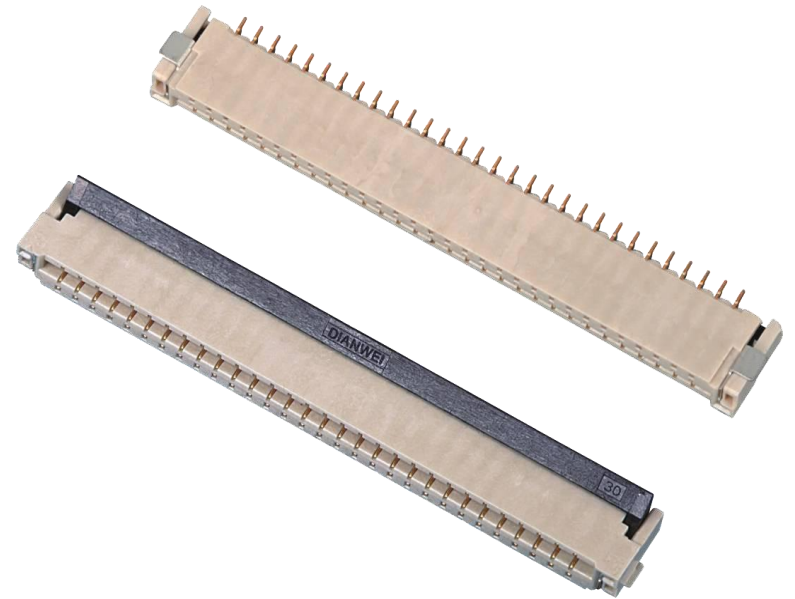

Application :
 car information systems (GPS/DVD etc) , tablet PCs , computer , medical , industrial control etc

main technical parameters :
 rating voltage : 50V (AC/DC) contact resistance : 100mΩ Max
 rating current : 0.5A/PIN insulation resistance : 50MΩ Min
 retention force : > 0.5N/PIN

material :
 Housing & cover : LCP contact terminal : phosphor bronze,Au plating

contact type : double contact

packing : 1500PCS/reel

thickness of flat cable : 0.3+/-0.02mm

PIN No. :
 4P、5P、6P、8P、10P、12P、13P、14P、15P、16P、18P、20P、24P、26P、27P、28P、30P、36P、40P。

8.05A0 Series 0.5mm FFC/FPC front swing cover connector H=1.8mm

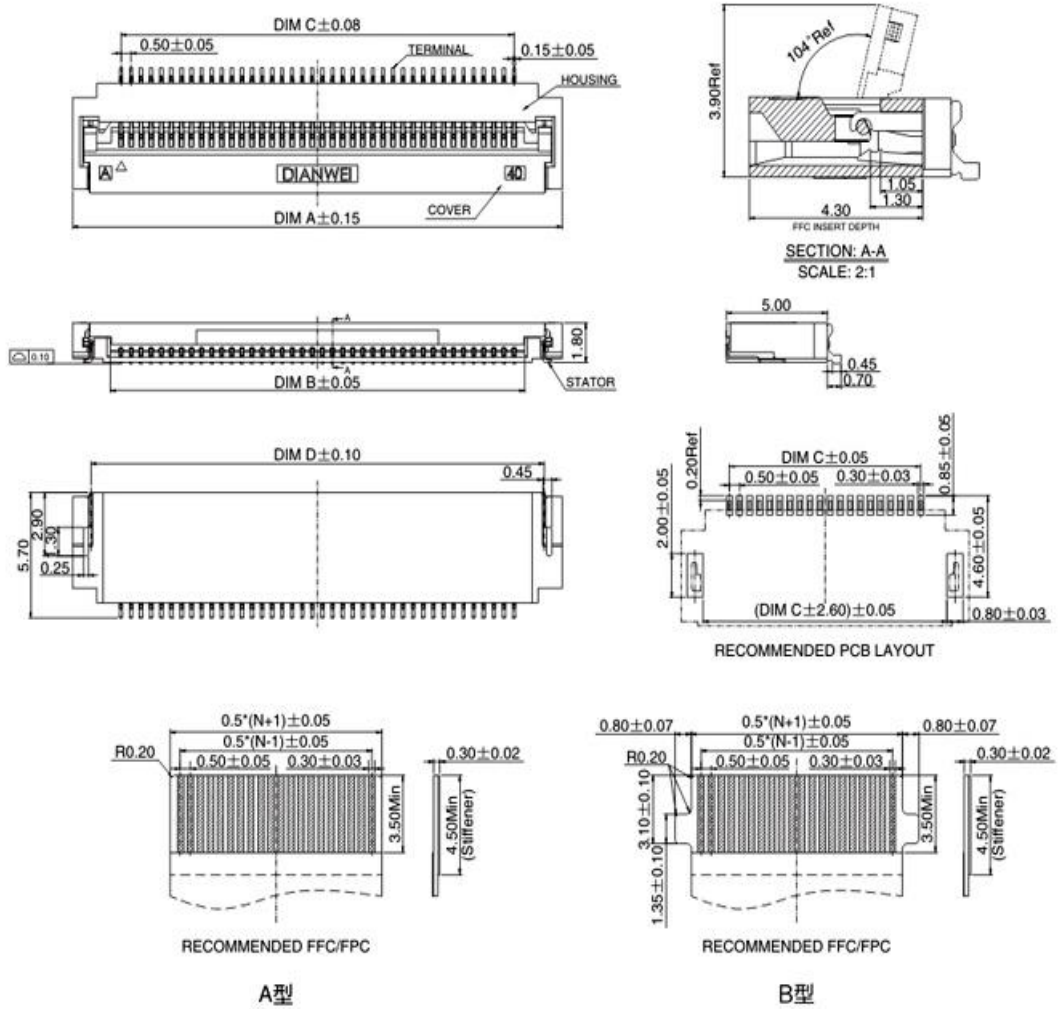

Pin No.	P/N	DIM A	DIM B	DIM C	DIM D
10	8.05A0.010200	9.30	5.56	4.50	7.50
20	8.05A0.020200	14.30	10.56	9.50	12.50
24	8.05A0.024200	16.30	12.56	11.50	14.50
30	8.05A0.030200	19.30	15.56	14.50	17.50
40	8.05A0.040200	24.30	20.56	19.50	22.50
41	8.05A0.041200	24.80	21.06	20.00	23.00
50	8.05A0.050200	29.30	25.56	24.50	27.50
51	8.05A0.051200	29.80	26.06	25.00	28.00
60	8.05A0.060200	34.30	30.56	29.50	32.50
61	8.05A0.061200	34.80	31.06	30.00	33.00
64	8.05A0.064200	36.30	32.56	31.50	34.50
65	8.05A0.065200	36.80	33.06	32.00	35.00
68	8.05A0.068200	38.30	34.56	33.50	36.50
70	8.05A0.070200	39.30	35.56	34.50	37.50
71	8.05A0.071200	39.80	36.06	35.00	38.00
75	8.05A0.075200	41.80	38.06	37.00	40.00
80	8.05A0.080200	44.30	40.56	39.50	42.50
81	8.05A0.081200	44.80	41.06	40.00	43.00
85	8.05A0.085200	46.80	43.06	42.00	45.00
90	8.05A0.090200	49.30	45.56	44.50	47.50
95	8.05A0.095200	51.80	48.06	47.00	50.00
96	8.05A0.096200	52.30	48.56	47.50	50.50
128	8.05A0.128200	68.30	64.56	63.50	66.50

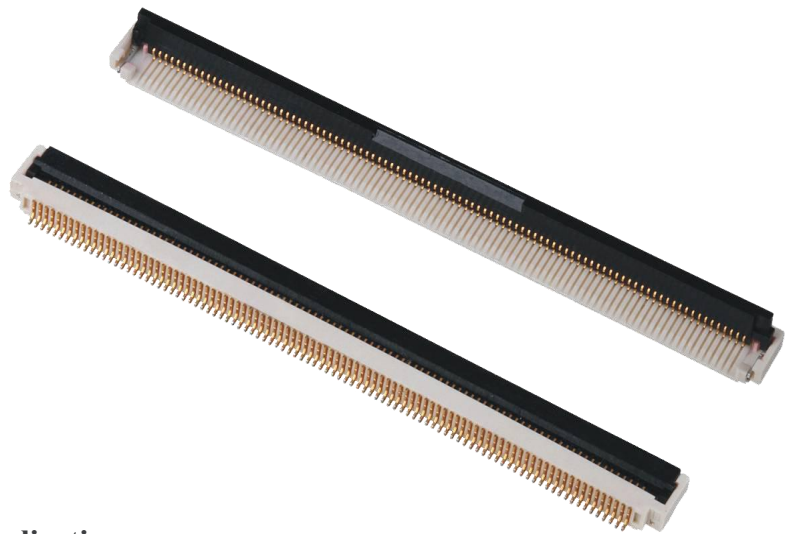

Application :

car information system (GPS/DVD etc) , LCD TV , tablet PCs , computer , medical , industry control etc

Main technical parameters :

rating voltage : 50V (AC/DC) contact resistance : 100mΩ Max
 rating current : 0.5A/PIN insulation resistance : 50MΩ Min
 retention force : > 0.5N/PIN

Material :

Housing & cover : LCP contact terminal : phosphor bronze ,Au plating

Contact type : bottom contact

Packing : 2000PCS/reel

Thickness of flat cable : 0.3+/-0.02mm

PIN No. :

10P、20P、24P、30P、40P、50P、60P、68P、80P、96P。

8.07A0 Series 0.5mm FFC/FPC dual contact with back locking connector (H=1.0mm)

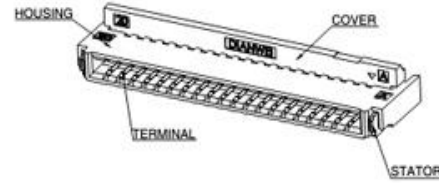
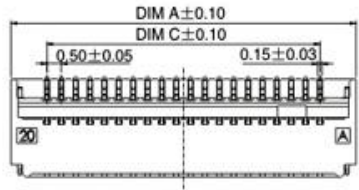

Pin No.	P/N	DIM A	DIM B	DIM C	DIM D	DIM E
4	8.07A0.004200	4.00	2.55	1.50	3.38	3.10
6	8.07A0.006200	5.00	3.55	2.50	4.38	4.10
7	8.07A0.007200	5.50	4.05	3.00	4.88	4.60
8	8.07A0.008200	6.00	4.55	3.50	5.38	5.10
9	8.07A0.009200	6.50	5.05	4.00	5.88	5.60
10	8.07A0.010200	7.00	5.55	4.50	6.38	6.10
11	8.07A0.011200	7.50	6.05	5.00	6.88	6.60
12	8.07A0.012200	8.00	6.55	5.50	7.38	7.10
14	8.07A0.014200	9.00	7.55	6.50	8.38	8.10
16	8.07A0.016200	10.00	8.55	7.50	9.38	9.10
20	8.07A0.020200	12.00	10.55	9.50	11.38	11.10
22	8.07A0.022200	13.00	11.55	10.50	12.38	12.10
23	8.07A0.023200	13.50	12.05	11.00	12.88	12.60
24	8.07A0.024200	14.00	12.55	11.50	13.38	13.10
25	8.07A0.025200	14.50	13.05	12.00	13.88	13.60
26	8.07A0.026200	15.00	13.55	12.50	14.38	14.10
28	8.07A0.028200	16.00	14.55	13.50	15.38	15.10
30	8.07A0.030200	17.00	15.55	14.50	16.38	16.10
32	8.07A0.032200	18.00	16.55	15.50	17.38	17.10
34	8.07A0.034200	19.00	17.55	16.50	18.38	18.10
35	8.07A0.035200	19.50	18.05	17.00	18.88	18.60
36	8.07A0.036200	20.00	18.55	17.50	19.38	19.10
40	8.07A0.040200	22.00	20.55	19.50	21.38	21.10
42	8.07A0.040200	23.00	21.55	20.50	22.38	22.10
45	8.07A0.045200	24.50	23.05	22.00	23.88	23.60
50	8.07A0.050200	27.00	25.55	24.50	26.38	26.10
52	8.07A0.052200	28.00	26.55	25.50	27.38	27.10
56	8.07A0.056200	30.00	28.55	27.50	29.38	29.10
60	8.07A0.060200	32.00	30.55	29.50	31.38	31.10

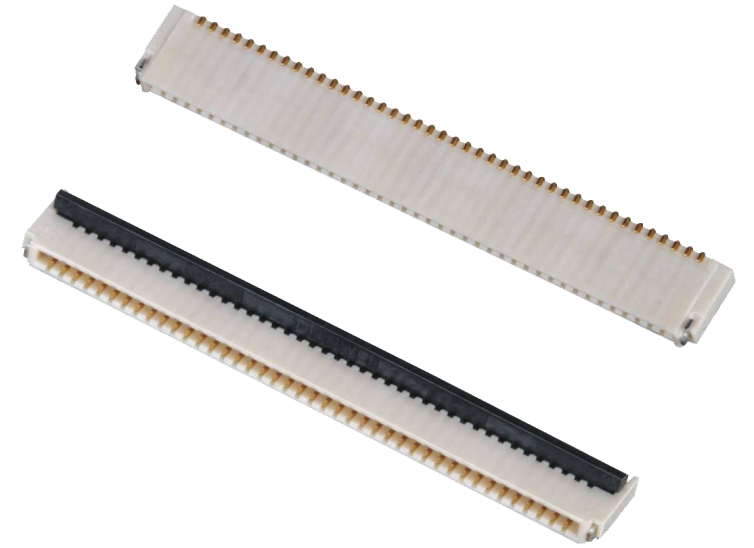

Application :

tablet PCs , smart phones , communications equipment,digital electronics etc ;also can develop new spec to meet client's need,like 0.2mm flat cable

Main technical parameters :

rating voltage : 50V (AC/DC) contact resistance : 100mΩ Max
 rating current : 0.5A/PIN insulation resistance : 50MΩ Min
 retention force : 大于0.3N/PIN

Material :

Housing & cover : LCP contact terminal : phosphor bronze,Au plating

Contact type : double contact

Packing : 3000PCS/reel

Thickness of flat cable : 0.3+/-0.02mm
 0.2+/-0.02mm

PIN No. :

4P、6P、8P、9P、10P、12P、14P、16P、18P、20P、22P、24P、30P、34P、40P、42P、50P.

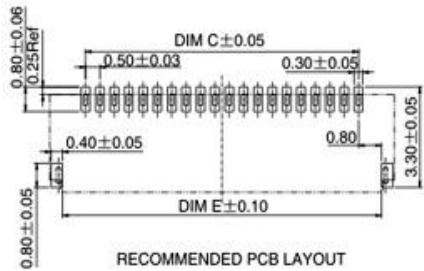
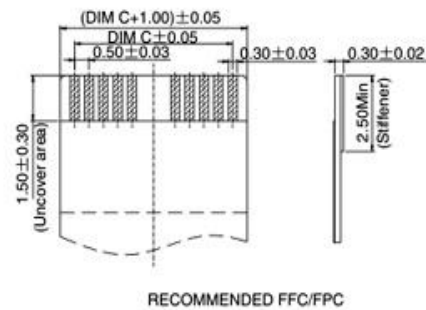
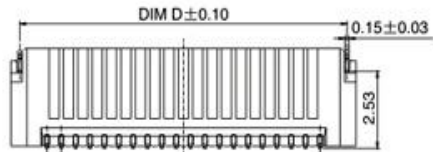
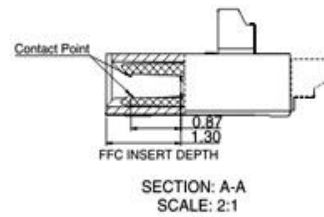
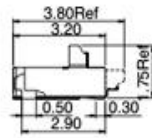
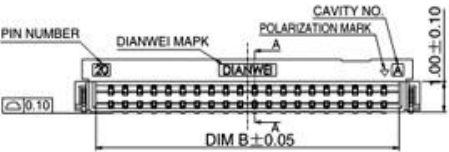

RECOMMENDED PCB LAYOUT

RECOMMENDED FFC/FPC

8.08A0 Series 0.5mm FFC/FPC front swing cover connector H=1.8mm

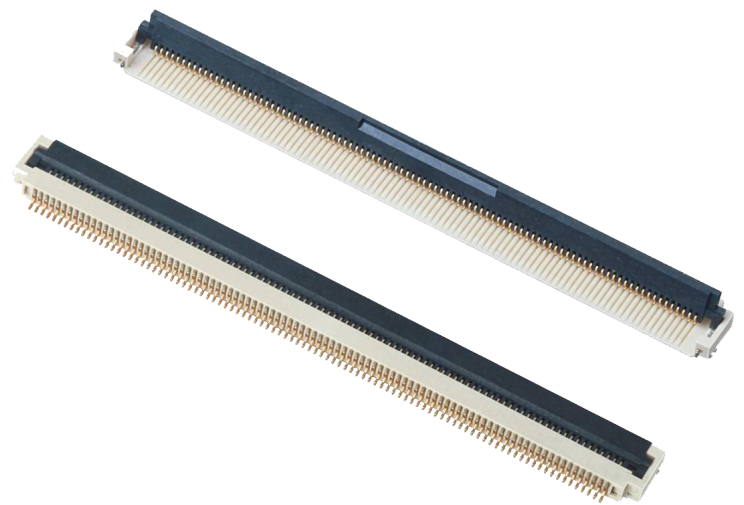
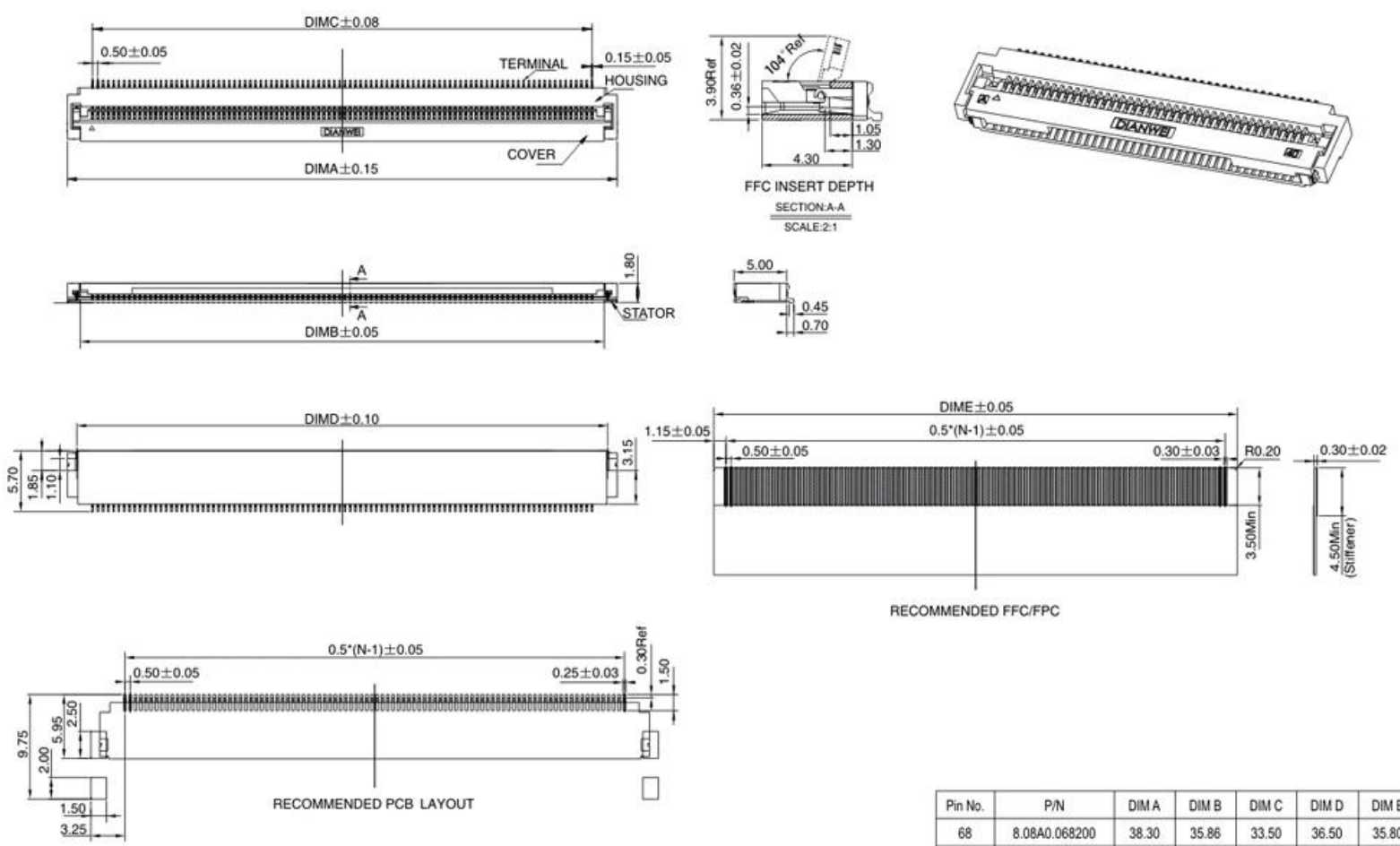

Application :

car information system (GPS/DVD etc) , LCD TV , tablet PCs , computer , medical , industry control etc.

Main technical parameters :

rating voltage : 50V (AC/DC) contact resistance : 100mΩ Max
 rating current : 0.5A/PIN insulation resistance : 50MΩ Min
 retention force : 大于0.5N/PIN

Material :

Housing & cover : LCP contact terminal : phosphor
 bronze,Au plating

Contact type : bottom contact

Packing : 2000PCS/reel

Thickness of flat cable : 0.3+/-0.02mm

PIN No. : 96P

Pin No.	P/N	DIM A	DIM B	DIM C	DIM D	DIM E
68	8.08A0.068200	38.30	35.86	33.50	36.50	35.80
80	8.08A0.080200	44.30	41.86	39.50	42.50	41.80
96	8.08A0.096200	52.30	49.86	47.50	50.50	49.80

8.09A0 series 0.5mm FFC/FPC front swing cover connector H=1.8mm

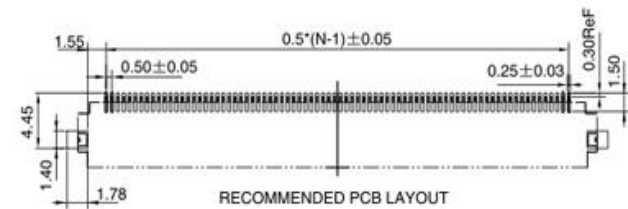
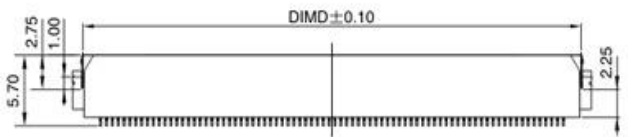
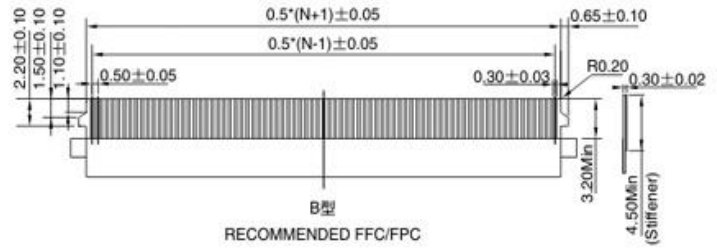
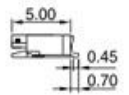
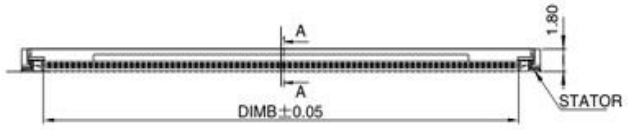
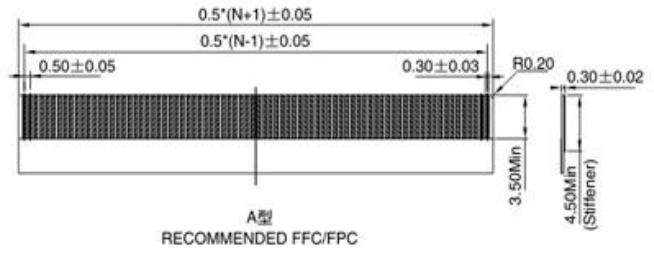
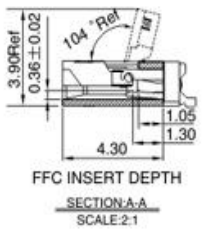
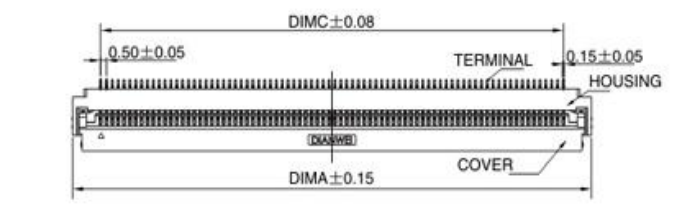

Application :

car information system (GPS/DVD etc) , LCD TV , tablet PCs , computer , medical , industry control etc

Main technical parameters :

rating voltage : 50V (AC/DC) contact resistance : 100mΩ Max
 rating current : 0.5A/PIN insulation resistance : 50MΩ Min
 retention force : > 0.5N/PIN

Material :

Housing & cover : LCP contact terminal : phosphor bronze,Au plating

Contact type : bottom contact

Packing : 2000PCS/reel

Thickness of flat cable : 0.3+/-0.02mm

PIN No. : 60P/80P

Pin No.	P/N	DIM A	DIM B	DIM C	DIM D
60	8.09A0.060200	34.30	30.56	29.50	32.50
80	8.09A0.080200	44.30	40.56	39.50	42.50

8.12A0 Series 0.5mm FFC/FPC vertical type connector (H=4.6mm)

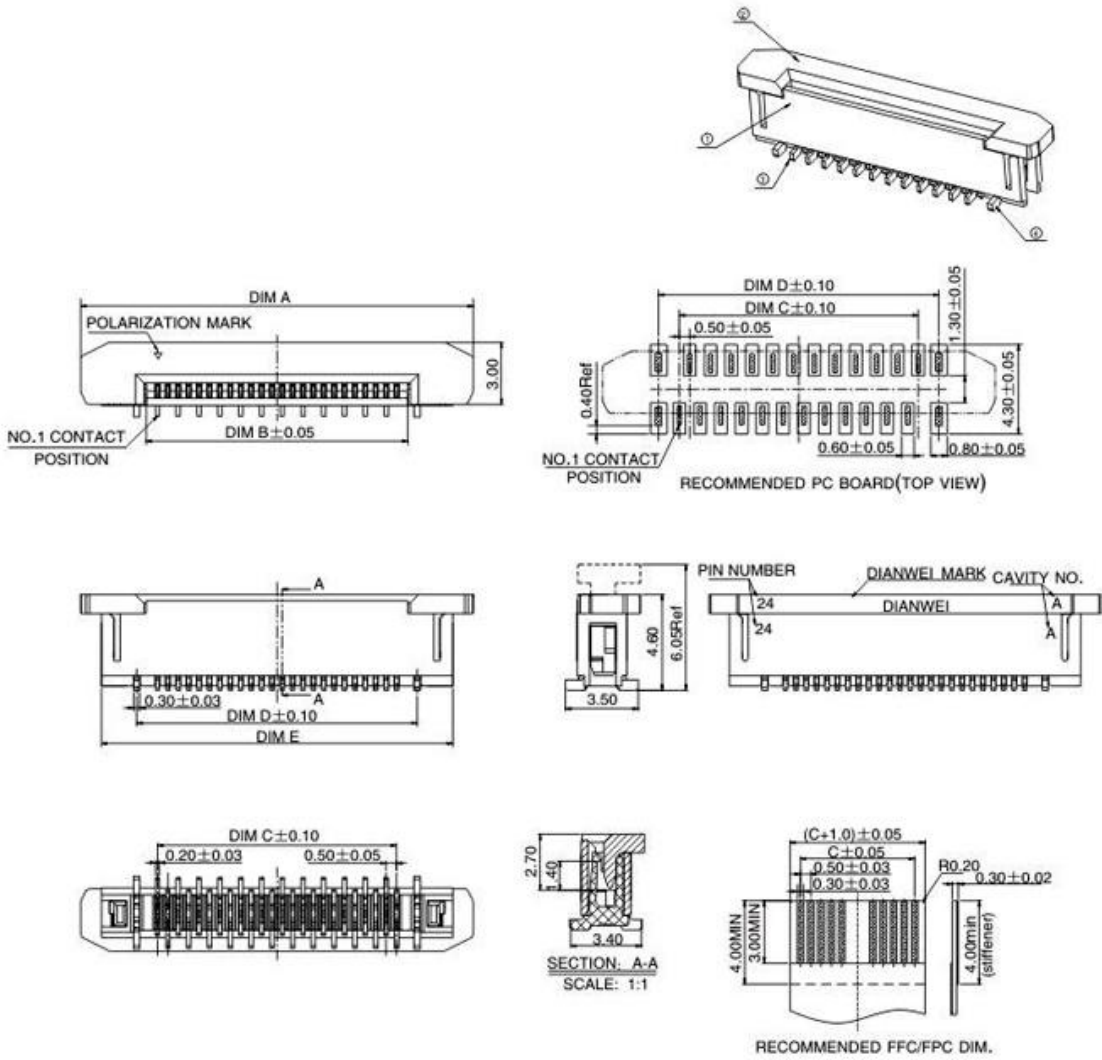

Pin No.	P/N	DIM A	DIM B	DIM C	DIM D	DIM E
4	8.12A0.004200	8.90	2.58	1.50	3.50	6.90
5	8.12A0.005200	9.40	3.08	2.00	4.00	7.40
6	8.12A0.006200	9.90	3.58	2.50	4.50	7.90
8	8.12A0.008200	10.90	4.58	3.50	5.50	8.90
9	8.12A0.009200	11.40	5.08	4.00	6.00	9.40
10	8.12A0.010200	11.90	5.58	4.50	6.50	9.90
12	8.12A0.012200	12.90	6.58	5.50	7.50	10.90
13	8.12A0.013200	13.40	7.08	6.00	8.00	11.40
14	8.12A0.014200	13.90	7.58	6.50	8.50	11.90
15	8.12A0.015200	14.40	8.08	7.00	9.00	12.40
16	8.12A0.016200	14.90	8.58	7.50	9.50	12.90
18	8.12A0.018200	15.90	9.58	8.50	10.50	13.90
20	8.12A0.020200	16.90	10.58	9.50	11.50	14.90
22	8.12A0.022200	17.90	11.58	10.50	12.50	15.90
24	8.12A0.024200	18.90	12.58	11.50	13.50	16.90
26	8.12A0.026200	19.90	13.58	12.50	14.50	17.90
28	8.12A0.028200	20.90	14.58	13.50	15.50	18.90
30	8.12A0.030200	21.90	15.58	14.50	16.50	19.90
32	8.12A0.032200	22.90	16.58	15.50	17.50	20.90
34	8.12A0.034200	23.90	17.58	16.50	18.50	21.90
35	8.12A0.035200	24.40	18.08	17.00	19.00	22.40
36	8.12A0.036200	24.90	18.58	17.50	19.50	22.90
40	8.12A0.040200	26.90	20.58	19.50	21.50	24.90
42	8.12A0.042200	27.90	21.58	20.50	22.50	25.90
45	8.12A0.045200	29.40	23.08	22.00	24.00	27.40
50	8.12A0.050200	31.90	25.58	24.50	26.50	29.90
52	8.12A0.052200	32.90	26.58	25.50	27.50	30.90
54	8.12A0.054200	33.90	27.58	26.50	28.50	31.90
55	8.12A0.055200	34.40	28.08	27.00	29.00	32.40
60	8.12A0.060200	36.90	30.58	29.50	31.50	34.90

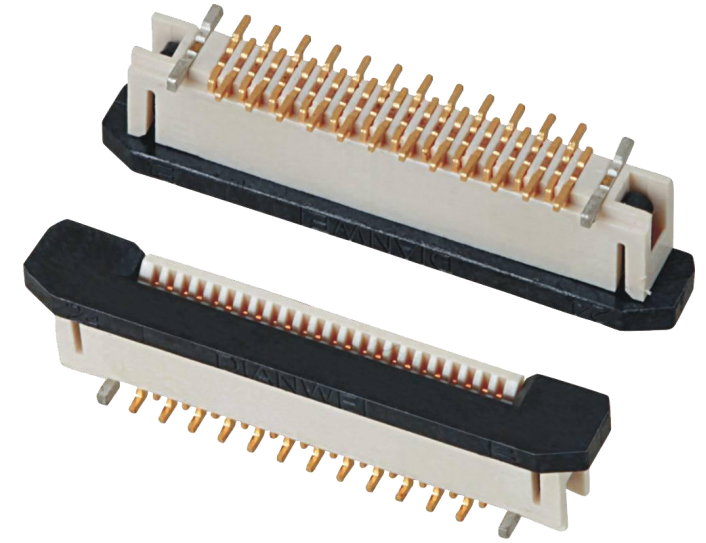

Application :

car information system (GPS/DVD etc) , tablet PCs , computer , medical , industry control etc

Main technical parameters :

rating voltage : 50V (AC/DC) contact resistance : 100m Ω Max
 rating current : 0.5A/PIN insulation resistance : 50M Ω Min
 retention force : > 0.5N/PIN

Material :

Housing & cover : LCP contact terminal : phosphor bronze,Au plating

Contact type : bottom contact

Packing : 1000PCS/reel

Thickness of flat cable : 0.3+/-0.02mm

PIN No. : 24PIN etc

8.13A0 Series 0.5mm FFC/FPC bottom contact horizontal connector (H=2.0mm)

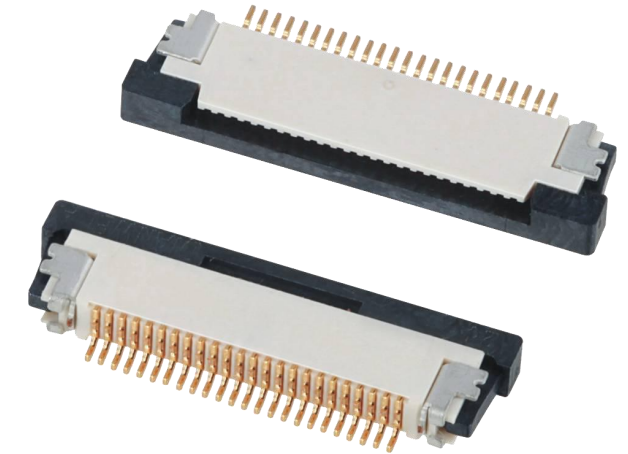
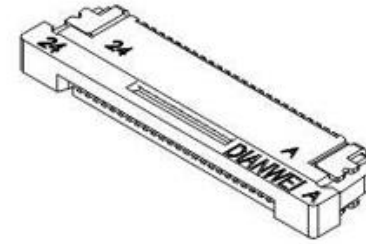
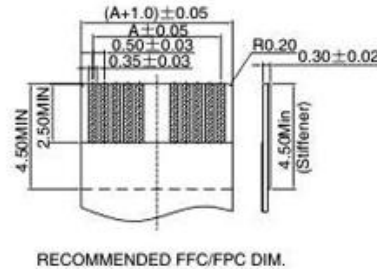
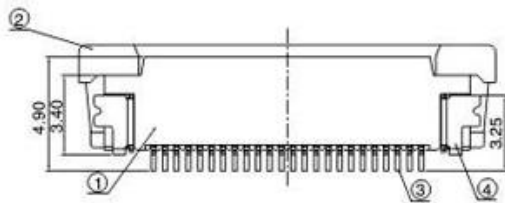
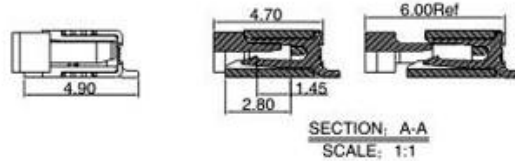
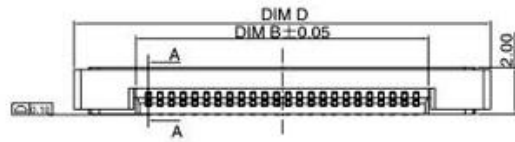
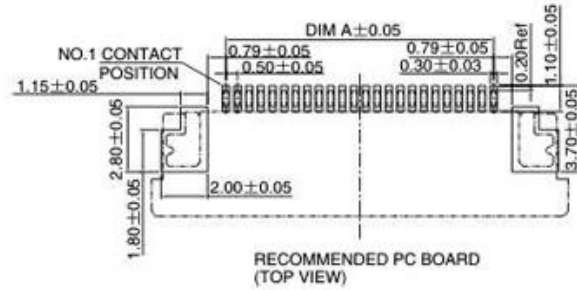
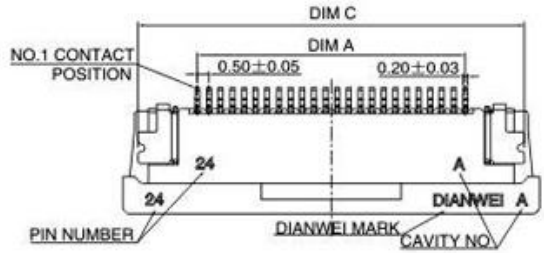

Pin No.	P/N	DIM A	DIM B	DIM C	DIM D
4	8.13A0.004200	1.50	2.56	6.60	7.90
5	8.13A0.005200	2.00	3.06	7.10	8.40
6	8.13A0.006200	2.50	3.56	7.60	8.90
8	8.13A0.008200	3.50	4.56	8.60	9.90
9	8.13A0.009200	4.00	5.06	9.10	10.40
10	8.13A0.010200	4.50	5.56	9.60	10.90
12	8.13A0.012200	5.50	6.56	10.60	11.90
13	8.13A0.013200	6.00	7.06	11.10	12.40
14	8.13A0.014200	6.50	7.56	11.60	12.90
15	8.13A0.015200	7.00	8.06	12.10	13.40
16	8.13A0.016200	7.50	8.56	12.60	13.90
18	8.13A0.018200	8.50	9.56	13.60	14.90
20	8.13A0.020200	9.50	10.56	14.60	15.90
22	8.13A0.022200	10.50	11.56	15.60	16.90
24	8.13A0.024200	11.50	16.60	16.60	17.90
26	8.13A0.026200	12.50	17.60	17.60	18.90
28	8.13A0.028200	13.50	18.60	18.60	19.90
30	8.13A0.030200	14.50	19.60	19.60	20.90

Application :

car information system (GPS/DVD etc) , tablet PCs , computer , medical , industry control etc

Main technical parameters :

rating voltage : 50V (AC/DC) contact resistance : 100mΩ Max
 rating current : 0.5A/PIN insulation resistance : 50MΩ Min
 retention force : > 0.5N/PIN

Material :

Housing & cover : LCP contact terminal : phosphor

Contact type : double contact

Packing : 1500PCS/reel

Thickness of flat cable : 0.3+/-0.02mm

PIN No. : 24PIN etc

8.19A0 series 0.5mm FFC/FPC dual contact side connector H=2.0mm

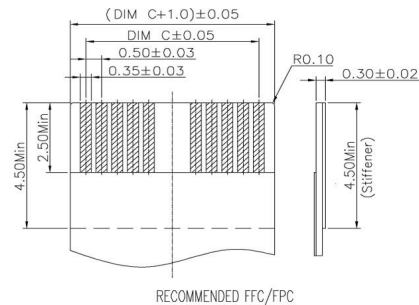
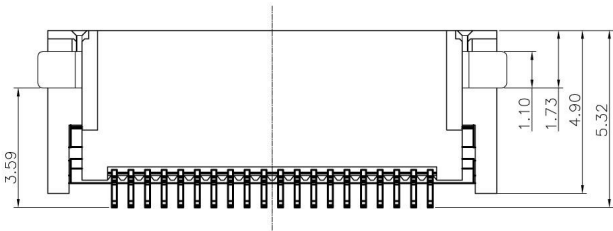
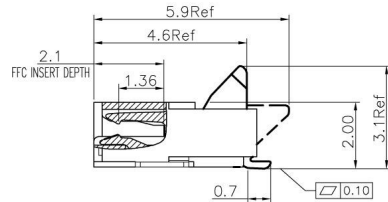
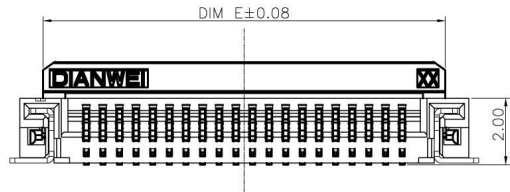
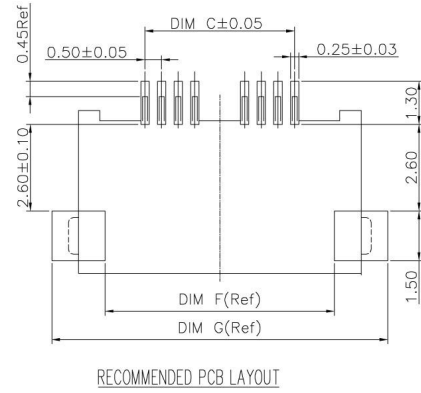
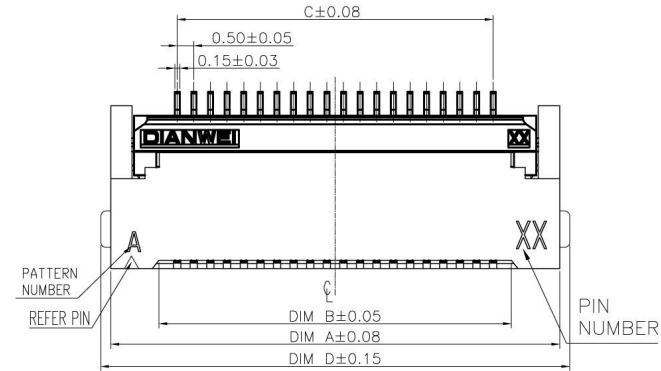
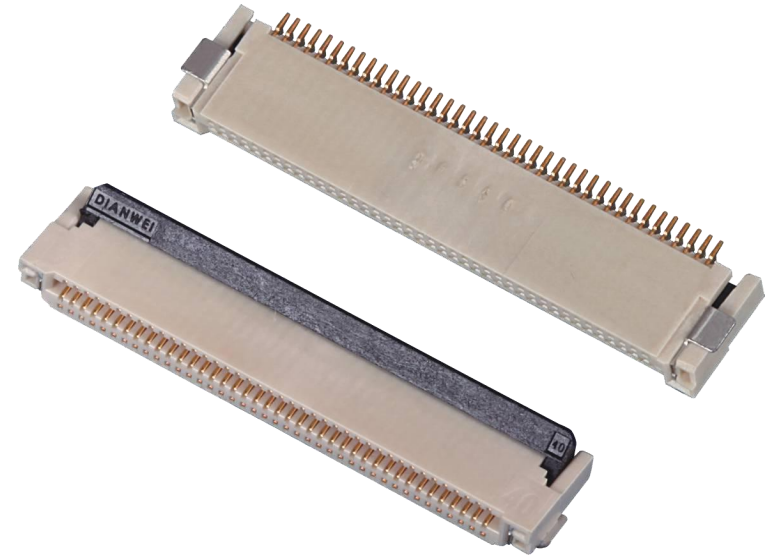

Pin No.	P/N	DIM A	DIM B	DIM C	DIM D	DIM E	DIM F	DIM G
4	8.19A0.004200	5.50	2.55	1.50	6.10	4.10	3.90	7.10
5	8.19A0.005200	6.00	3.05	2.00	6.60	4.60	4.40	7.60
6	8.19A0.006200	6.50	3.55	2.50	7.10	5.10	4.90	8.10
8	8.19A0.008200	7.50	4.55	3.50	8.10	6.10	5.90	9.10
9	8.19A0.009200	8.00	5.05	4.00	8.60	6.60	6.40	9.60
10	8.19A0.010200	8.50	5.55	4.50	9.10	7.10	6.90	10.10
12	8.19A0.012200	9.50	6.55	5.50	10.10	8.10	7.90	11.10
14	8.19A0.014200	10.50	7.55	6.50	11.10	9.10	8.90	12.10
15	8.19A0.015200	11.00	8.05	7.00	11.60	9.60	9.40	12.60
16	8.19A0.016200	11.50	8.55	7.50	12.10	10.10	9.90	13.10
18	8.19A0.018200	12.50	9.55	8.50	13.10	11.10	10.90	14.10
20	8.19A0.020200	13.50	10.55	9.50	14.10	12.10	11.90	15.10
22	8.19A0.022200	14.50	11.55	10.50	15.10	13.10	12.90	16.10
24	8.19A0.024200	15.50	12.55	11.50	16.10	14.10	13.90	17.10
26	8.19A0.026200	16.50	13.55	12.50	17.10	15.10	14.90	18.10
28	8.19A0.028200	17.50	14.55	13.50	18.10	16.10	15.90	19.10
30	8.19A0.030200	18.50	15.55	14.50	19.10	17.10	16.90	20.10
32	8.19A0.032200	19.50	16.55	15.50	20.10	18.10	17.90	21.10
34	8.19A0.034200	20.50	17.55	16.50	21.10	19.10	18.90	22.10
35	8.19A0.035200	21.00	18.05	17.00	21.60	19.60	19.40	22.60
36	8.19A0.036200	21.50	18.55	17.50	22.10	20.10	19.90	23.10
38	8.19A0.038200	22.50	19.55	18.50	23.10	21.10	20.90	24.10
40	8.19A0.040200	23.50	20.55	19.50	24.10	22.10	21.90	25.10
41	8.19A0.041200	24.00	21.05	20.00	24.60	22.60	22.40	25.60
42	8.19A0.042200	24.50	21.55	20.50	25.10	23.10	22.90	26.10
45	8.19A0.045200	26.00	23.05	22.00	26.60	24.60	24.40	27.60
50	8.19A0.050200	28.50	25.55	24.50	29.10	27.10	26.90	30.10
51	8.19A0.051200	29.00	26.05	25.00	29.60	27.60	27.40	30.60
52	8.19A0.052200	29.50	26.55	25.50	30.10	28.10	27.90	31.10
54	8.19A0.054200	30.50	27.55	26.50	31.10	29.10	28.90	32.10
55	8.19A0.055200	31.00	28.05	27.00	31.60	29.60	29.40	32.60
58	8.19A0.058200	32.50	29.55	28.50	33.10	31.10	30.90	34.10
60	8.01A0.060200	33.50	30.55	29.50	34.10	32.10	31.90	35.10

Application :

car information systems (GPS/DVD etc) , tablet PCs , computer , medical , industrial control etc

main technical parameters :

rating voltage : 50V (AC/DC) contact resistance : 100mΩ Max
 rating current : 0.5A/PIN insulation resistance : 50MΩ Min
 windin retention : > 0.5N/PIN

material :

Housing & Cover : LCP contact terminal : phosphor bronze,Au plating

Contact type : double contact

packing : 1500PCS/reel

thickness of flat cable : 0.3+/-0.02mm

PIN No. :

4P、6P、8P、9P、10P、12P、14P、15P、16P、18P、20P、22P、24P、26P、28P、30P、32P、34P、35P、36P、40P、41P、42P、45P、50P、51P、52P、54P、55P、60P。

Customized Parts

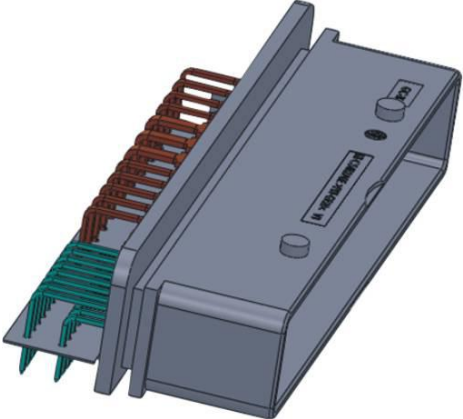

38PIN automotive connector

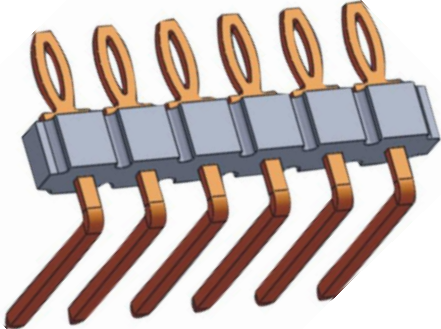

Finsheye connector



Automotive plastic parts car headlight left / right hoop

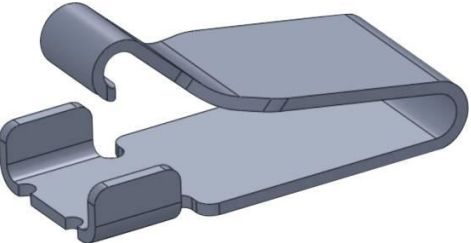

1.2H spring

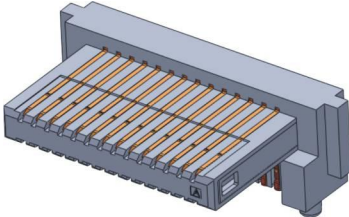

ketch plate BTB male connector

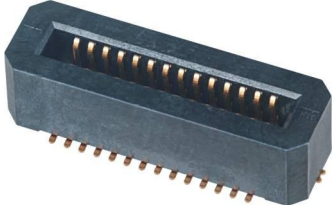

Sketch plate BTB female connector

Application

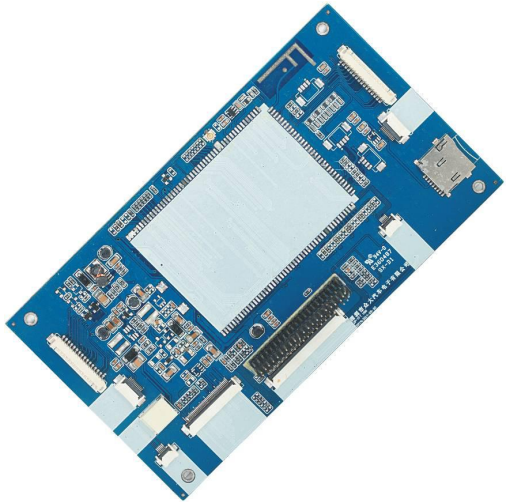
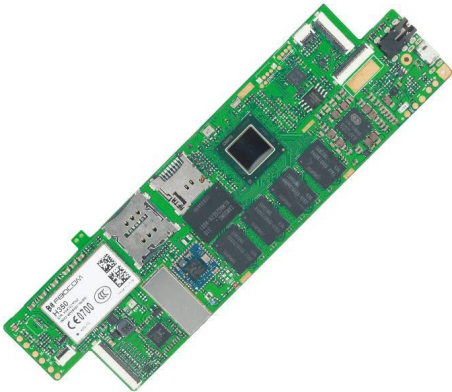
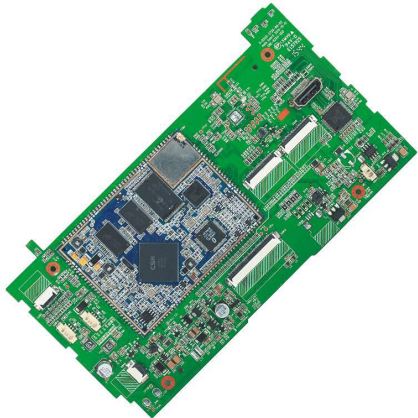
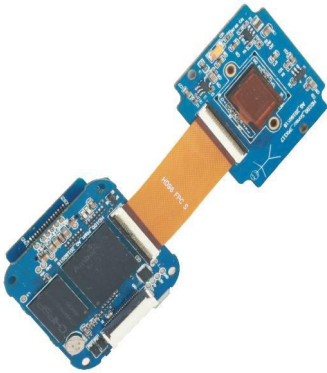

Our Customers



lenovo 联想



BOSCH

博世

TRANSSION
传音控股



YUTONG

Hisense
海信

Skyworth
创维

BBK
步步高®

MI 小米

ROAD REVER
路畅科技

DESAY 德赛
科技无限 文明共享



小天科

LittleSwan

THANK YOU

Shenzhen DianWei technology co.,ltd

Add : room321,Dongming building,Minkang Road,Mingzhi street,Longhua,shenzhen

Tel : +86-755-29059311

Fax : +86-755-29059310

Dongguan DianWei electronic technology co.,ltd

Add : No.22,DAlingbian Road,Shahu Community,Tangxia,Dongguan

Tel : +86-769-8788-8322

Fax : +86-769-8788-8321

website : <http://www.dianwei.cn>

web shop : <http://www.gdconn.com>



Website



Web shop